





THE QUEEN'S AWARDS  
FOR ENTERPRISE  
INTERNATIONAL TRADE  
2021

# AES

## Bringing you the latest access control systems to secure your home.

We are one of the largest manufacturers of **GSM, wireless,** and **IP** audio and video intercoms. Many of our access control products, including the **Tomalok electric gate bolt** and the **E-Loop wireless vehicle detection** system, are available for purchase through dealers and sales outlets in over 40 countries worldwide. All our products come with a 2-year warranty and free technical support.

Our intercoms and access control systems are crafted from the highest quality materials, available in a range of technologies to suit various entrance types and applications. We use brushed BS316 marine-grade stainless steel for corrosion resistance, while some units feature black powder-coated steel. For custom colours, please contact your sales representative. Our durable, gloss acrylic faceplates add a modern touch, making our units a stylish and resilient choice for any entrance.



# CONTENTS



## IP VIDEO INTERCOM SYSTEMS

OPYN VIDEO INTERCOM	5 - 6
OPYN MONITOR	7
OPYN-PRO INTERCOM	8 - 9
OPYN-MULTI VIDEO INTERCOM	10 - 12
I-GATE-WIFI (GATE SWITCH)	13



## GSM INTERCOM SYSTEMS

CELLCOM PRIME-EDGE	15 - 16
CELLCOM LITE 2	7
CELLCOM LINK	18
MULTICOM CLASSIC	19 - 20
I-GATE PLUS	21
I-GATE DUAL	22
AES-IM	23
KEYCELL (STANDALONE KEYPAD SYSTEM)	24 - 25



## WIRELESS INTERCOM SYSTEMS

DECT 603 WIRELESS AUDIO INTERCOMS	27 - 29
DECT 703 WIRELESS AUDIO INTERCOMS FOR	30 - 31



## SPECIAL PRODUCT RANGES

MODULAR RANGE	33 - 34
BESPOKE	35 - 36
E-LOOP RANGES	37 - 44
TOMALOK - ELECTRIC GATE BOLT	45 -- 46
RESOURCES	47

IP/4G

# IP-4G

Smart phone IP Video Intercom System.

GSM

WIRELESS



SPECIAL PRODUCT



FC  
CE

# Opyn

## Advanced IP Video Intercom

**Interact with your caller no matter where you are. Stay connected anytime, anywhere.**

Establish a connection using \*IP/LAN connection. 4G kits offer internet access through a compatible SIM card.

\*For a more reliable connection, we recommend using a wired or 4G connection.



2x Relays.



Nightvision.



LED Luminance (Night time).



Voice Control via Alexa/Google Integration.



Tamper Alarm.



Set automatic opening times via Opyn app.



Scan QR code unlock. Ability to set validity time & the number of uses or make both unlimited.



Motion detection alerts, use app to playback footage from online server.



View live camera feed via app.



Image/Video download.



Multiple users/devices same account online in app.



Ability to add 3 customized voicemail messages and set one to play when the call is not accepted.



Activity Log.

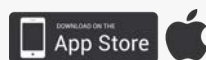

### Details

Max Users (Share device via app, qr or link)	Unlimited	Relays	2
Keypad Codes - Ability to set validity times / number of uses or make both unlimited.	150	Relay Type	N/C and N/O
QR Codes	150	Relay Load	3A, 30V DC/250AC
Activity Log Display	SD Card	Power Consumption	300mA on dial out, 2amp peak demand
WIFI (2,4 & 5 GHz)	Yes	Working Voltage	24V DC, 48V POE
LAN	Yes	SD Card	128GB Max (8GB card included)
Operation Temperature	-20 to +55	Camera Angle	130H, 70V, 150D
IP Rating	IP54	Video Resolution	1080, 720, 640*360

\*Wifi antenna sold separately.

# Kits & part numbers



## OPYN-4G-IBK

Kit comes with hooded imperial video intercom in black powder coated with white light illumination. 4G modem, SIM card options & power supply.

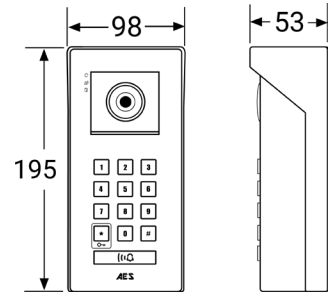

Works with our multi network AESIM.



[aesglobaltelecom.com](http://aesglobaltelecom.com)



## OPYN-IP-IBK

Kit comes with hooded imperial video intercom in black powder coated with white light illumination. Power supply included.

**\*Wifi antenna sold separately.**

**\*For a more reliable connection, we recommend using a wired or 4G connection.**

## WIFIA-10-KIT

2.4Ghz Wifi Antenna with 10m Lead. Including a mounting bracket.



## OPYN 45 Degree Bracket

Ensure your Opyn Video Intercom is positioned exactly where it needs to be. The new 45° Angle Bracket makes installation more flexible and improves usability for both drivers and pedestrians.

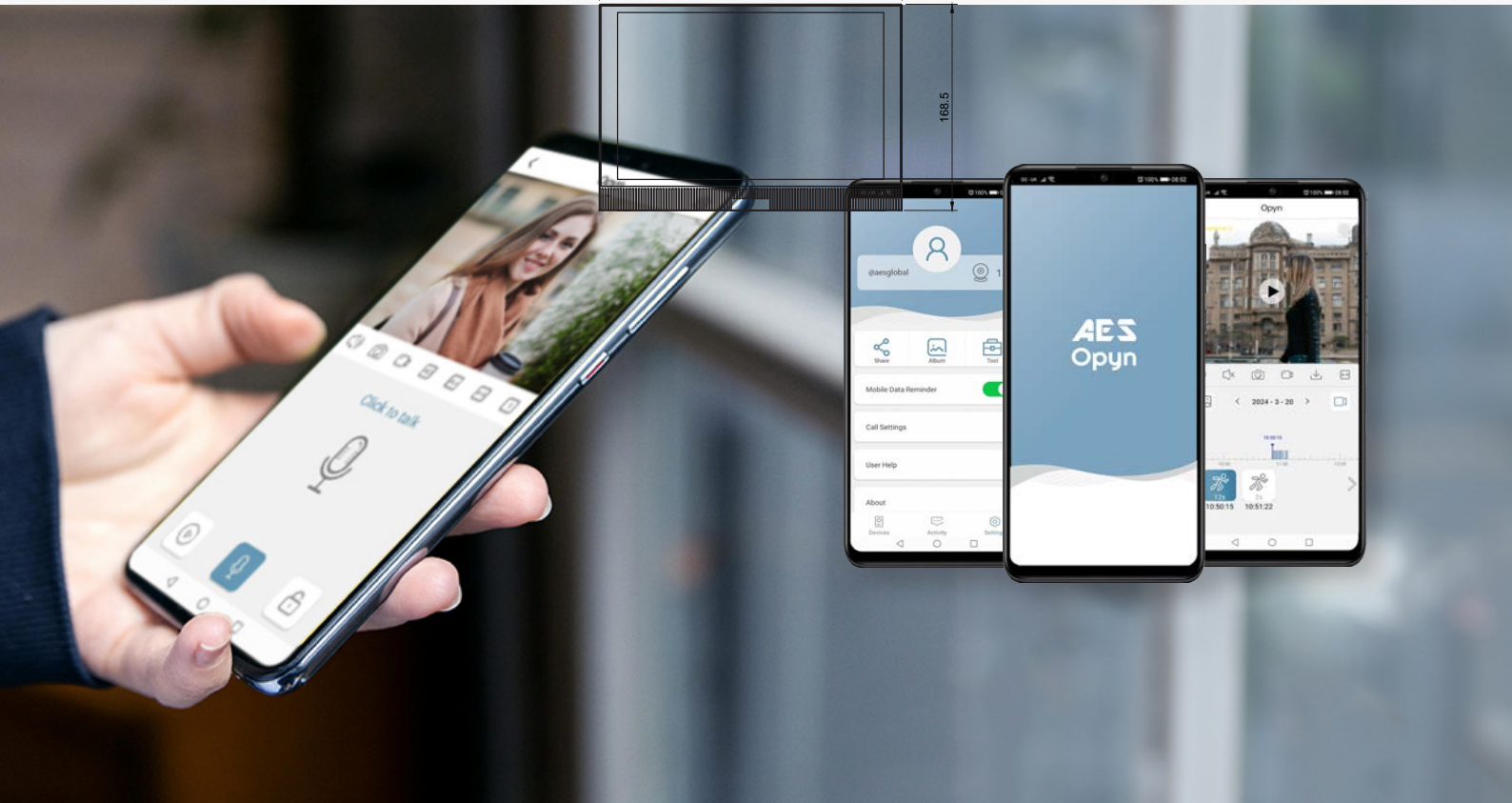
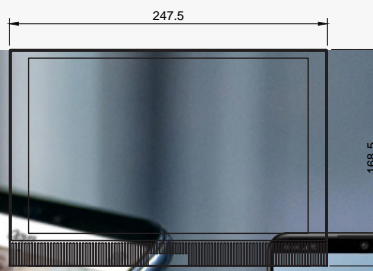



## OPYN-MON

IP - Touchscreen Monitor. The Opyn monitor can be purchased as an **added accessory to all kits\***.

- Wall mountable touchscreen monitor (1024x600 Resolution), compatible with the Opyn system.
- 7" IPS screen.
- 10" IPS Screen
- SIP Integration.
- IP Camera Integration.
- Android App Integration.
- Wi-Fi & Ethernet connections.

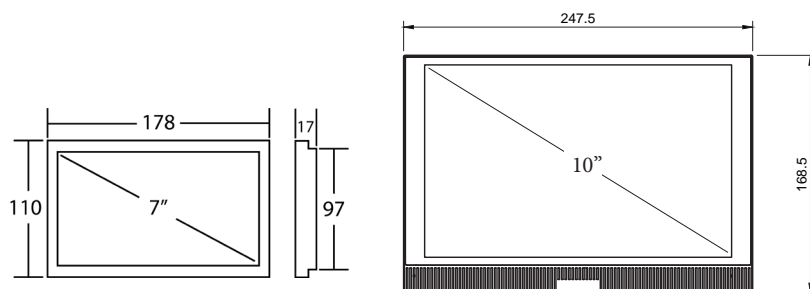

### OPYN-MON-DESK

A desk mount bracket is available. (Sold separately)

\*The Opyn-Mon is sold separately and can be used as an optional accessory with the Opyn, Opyn-Pro, and Opyn-Multi ranges.

# Opyn-Pro

## IP Video Intercom

Introducing the Opyn-Pro, the latest addition to our Opyn range. We've integrated our Opyn technology into our iconic intercom design.

Interact with your caller no matter where you are. Stay connected anytime, anywhere.

Establish a connection using IP/LAN connection. 4G kits offer internet access through a 4G router with a compatible SIM card.

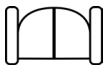

2x Relays.



Nightvision.



LED Luminance (Night time).



Voice Control via Alexa/Google Integration.



Prox reader as standard.



White or Blue LEDs



## Opyn App



Set automatic opening times via Opyn app.



Scan QR code unlock. Ability to set validity time & the number of uses or make both unlimited.



Motion detection alerts, use app to playback footage from online server.



View live camera feed via app.



Image/Video download.



Multiple users/devices same account online in app.



Ability to add 3 customized voicemail messages and set one to play when the call is not accepted.



Activity Log.



Details

Max Users (Share device via app, qr or link)	Unlimited	Relays	2
Keypad Codes - Ability to set validity times / number of uses or make both unlimited.	150	Relay Type	N/C and N/O
QR Codes	150 each	Relay Load	3A, 30V DC/250AC
Activity Log Display	SD Card	Power Consumption	24V, 800mA, 48V, 400mA POE - 250mA
WIFI (2,4 & 5 GHz)	Yes	Working Voltage	24V DC, 48V POE
LAN	Yes	SD Card	128GB Max (8GB card included)
Operation Temperature	-30 to +65	Camera Angle	120°(D) 109°(H) 65°(V)
IP Rating	IP55	Video Resolution	1080, 720

### Kits & part numbers



robustel



### OPYN-PRO-4G-ABK

- Architectural unit with backlit, black powder-coated stainless-steel wings.
- 4G Robustel modem, with SIM card options.
- Power supply.



Works with our multi network AESIM.

[aesglobaltelecom.com](http://aesglobaltelecom.com)

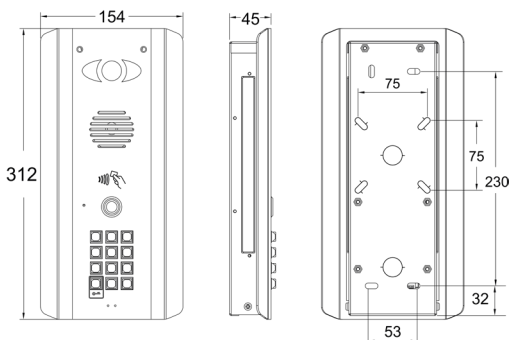

Architectural ABK

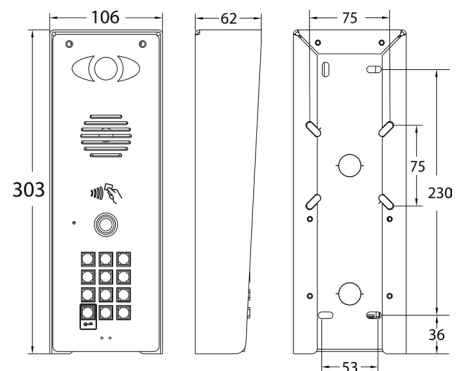

Imperial IBK

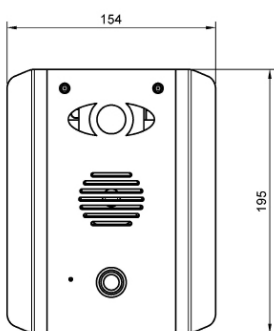

AB

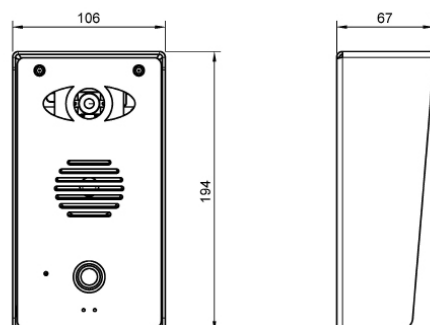

IB

\*Other Intercom designs coming soon.

# Opyn-multi

## IP Multi-Apartment Intercom

The Opyn-multi Intercom is an android-based system with a touch-screen experience. With a 7-inch LCD display, the system is capable of many interactive aspects. The Opyn-multi will be available as an IP system with LAN cable required for internet connection or 4G access through a compatible SIM card.

**Facial recognition unlocking for quick and effortless access.**

**QR code unlocking with options for timed or temporary access.**

**Option to add multiple screensavers, displaying up to 3 that rotate every 30 seconds (9:16 ratio).**

- Visitors call an apartment from home screen.
- 7" IPS LCD Display. RES: 600x1024.
- Customise, screen brightness & volume/tones/alarm settings.
- Nightvision LED strip.
- Tamper Alarm.
- Ability to integrate IP cameras.
- 2x Relays.

### Details

Keypad Codes / Prox cards & tags	10,000 Each	Relays	2
QR Codes	10,000	Relay Type	N/C and N/O
Facial Recognition	10,000	Relay Load	3A, 30V DC/250AC
Activity Log	Cloud Storage	Power Consumption	12V MAX - 1.58A, 48V Max - 0.40A
Max Users (Share device via app, qr or link)	Unlimited	Power Supply	12-15V DC / 48V POE (802.3AF)
ETHERNET (IEEE 802.3)	Yes	Camera	2 Megapixels
Operation Temperature	-40 to +65	Display Resolution	HD-1080P, SD-720P, LD-640*360P
IP Rating	IP65	Night Vision	IRCUT, Infrared LED
Protocol	Wiegand 26 & 34	Frequency	13.56Mhz (MIFARE & NFC)



## Management Portal.

- Create and manage sites all in one place.
- Set up users and assign each panel and user to their respective "sites/buildings".
- Adjust roles & permissions for different types of users.
- Obyn Multi Only

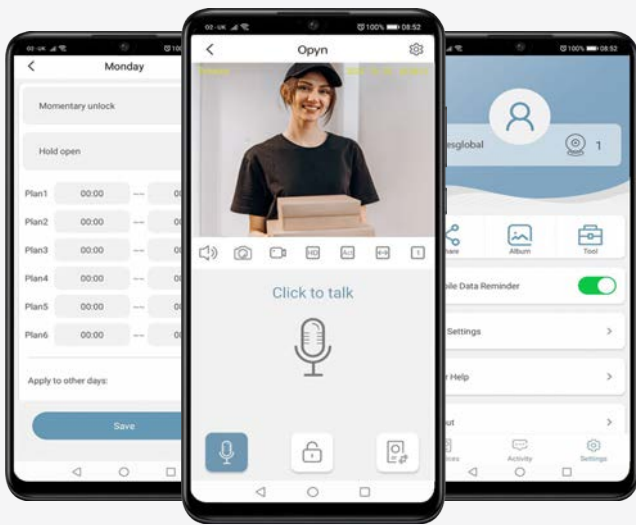

## AES OPYN APP.

The AES Obyn mobile app is essential for panel users. It lets you manage keypad codes, facial IDs, upload profile pictures, invite users, activate locks, and more. Key features are outlined below.



Scan QR code unlock. Ability to set validity time & the number of uses or make both unlimited.

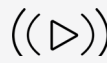

View and talk to caller via app, plus view live camera feed.



Image/Video download.



Activity Log.



# Obyn-Multi

INTERACTIVE ACCESS, ANYWHERE

# Opyn-Multi

## Kits & part numbers

### 4G Kits

The system is available in two different appearances, "Flush Mount" or "Surface Mount". 4G units come with a built-in 4G modem allowing the use of a SIM card to give the system a network connection.

#### OPYN-MULTI-4G-IB

The kit includes a **surface-mount** black video call point with touchscreen display, a power supply, built in 4G modem, and SIM card options and GSM ariel.



#### OPYN-MULTI-4G-FB

The kit includes a flush-mount black video call point with touchscreen display, a power supply, built in 4G modem, and SIM card options and GSM ariel.



Works with our multi network AESIM.  
[aesglobaltelecom.com](http://aesglobaltelecom.com)

## IP Kits

The system is available in two different appearances, "Flush Mount" or "Surface Mount". IP units need an ethernet cable (LAN) for network connection.

#### OPYN-MULTI-IP-IB

The kit includes a surface-mount black video call point with touchscreen display and a power supply.



#### OPYN-MULTI-IP-FB

The kit includes a flush-mount black video call point with touchscreen display and a power supply.



# i-GATE WiFi

## An innovative IP Switch for gates, barriers and doors!

Elevate your connectivity with our user-friendly IP solution. Choose between Din Rail or iGate Enclosure mounting for adaptability. Connecting seamlessly to 2.4GHz WiFi networks, this compact device ensures clutter-free spaces with a range of up to 50+ meters (depending on router location & obstructions). Simplify your setup and enhance performance with our compact and versatile WiFi Connectivity Solution.

Available as an outdoor install via i-Gate enclosure or Din Rail installed into the gate motor.



### IGATE-WIFI-ENC

i-Gate enclosure for outside install.



### IGATE-WIFI

i-Gate Din Rail for inside enclosure install.



Voice control via alexa.

DETAILS	
Weather Rating Din Rail	IP20
Weather Rating Outdoor encloser	IP67
Relay Type	N/O, N/C & COM (Trigger Only)
Switching Socket (Relay)	3A
Relay pulse time	0.3 sec - 4 sec
Working frequency	WIFI (b/g/n) 2.4Ghz
Network topology	Wireless Communication
Charging block	8-36V AC/DC



Control at your fingertips through our app, ensuring seamless and convenient operation.

### Features:

- Add multiple devices to one app
- Activate relay via app. (Trigger/latch)
- Share devices with other users
- Change device icon/animation to suit customers use
- Adjust relay activation time.
- Activity log
- Automatic opening times (schedule)
- Boost mode



\*App visuals may vary.

IP/4G

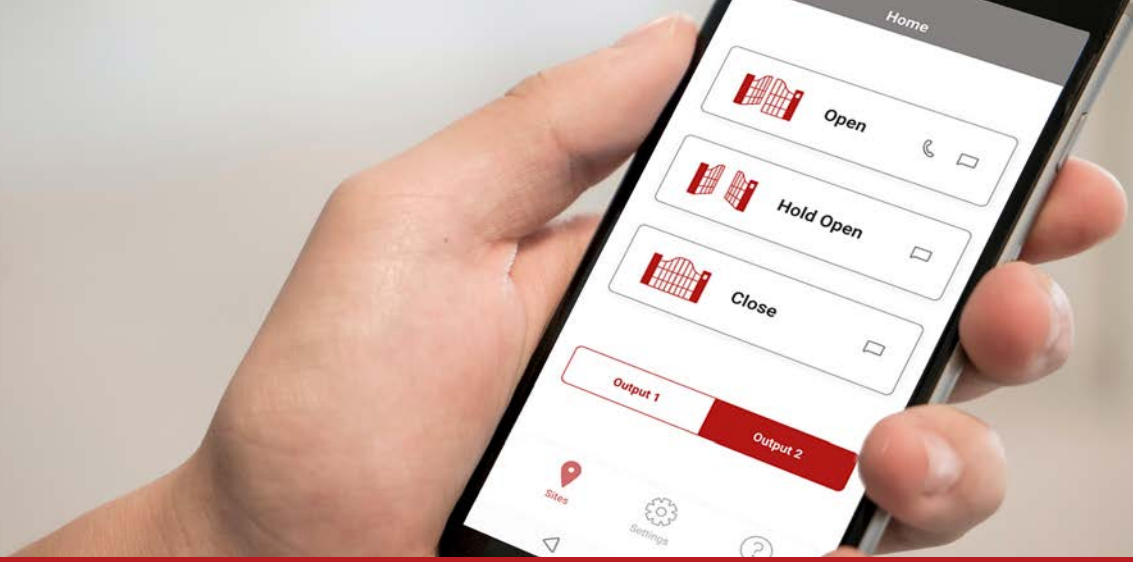

GSM

# GSM

Intercoms For Talking & Operating  
Your Door/Gates By Phone.

WIRELESS

SPECIAL PRODUCT



## Enhanced GSM Intercom

Never miss a visitor or call – this unit automatically dials your home, office, or mobile phone in sequence when someone presses the call button.



Keypad Lockout feature enabled by default to enhance security.



Fully customisable LED lighting in blue or white.



Weekly Do Not Disturb (DND) times, as well as new Holiday DND feature.



Automatic Daylight Saving Time (DST) setting.



Customisable SMS replies to Trigger, Latch and Unlatch commands.



Automatic APN detection on selected major networks.



FOTA – Upgrade firmware via SMS.



Remote SMS diagnostics features including modem reboot and dial test.



Two-Factor Authentication (2FA) option for added security (Keypad and Prox).



Comprehensive Events Log including Missed Calls and failed Keypad Code attempts.



Antenna.

Works with our multi network AESIM. [aesglobaltelecom.com](http://aesglobaltelecom.com)



USB-C

DETAILS			
Dial Out Numbers	4	Relays	2
Permanent Codes/Cards	250	Relay Type	N/C and N/O
Time Restricted Codes/Cards	250	Relay Load	2 Amps, 24V AC max
Temporary Codes/Cards	50	Power Consumption	200mA on dial out, 2 Amp peak demand
Automatic Trigger Events per Week	50	Modem Models	4G EU, 4G USA, 4G AUS/NZ
Caller ID Numbers	250	Power Supply	24V DC (24V DC 2A adaptor included)
Time Restricted Caller ID Numbers	250	Prox model	125 kHz



### AES PRO APP

The ideal app for **installers**, offering the ability to program intercoms across multiple sites and including additional features.

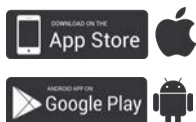

### AES HOME APP

The user-friendly option allows the **end user** to program their AES intercom conveniently.

## Kits & part numbers

The Cellcom Prime EDGE range is available in a variety of intercom panel options and is DDA compliant, ensuring accessibility for users with disabilities.

Each kit contains, a speech panel, power supply, digital quick start guide, sim card options, and an antenna.

GSM



**PRIME-EDGE-ABK**

ARCHITECTURAL MODEL – Stylish panel with backlighting.

Black/powder coated steel panel with fully customisable blue or white lighting.

Metal Keypad and Prox reader as standard.



**PRIME-EDGE-AB**



**PRIME-EDGE-IBK**

IMPERIAL MODEL – Sleek all-black panel.

All black panel with fully customisable blue or white lighting.

Metal Keypad and Prox reader as standard.



**PRIME-EDGE-IB**



# CELLCOM

Simple, Effective GSM Intercom



## The new Version 2 of our Cellcom Lite range audio GSM intercom with updated features.

With a mobile connection, you'll never miss a visitor. When someone presses the call button, it rings your home phone or mobile, allowing you to talk to them wherever you are.



USB-C



FOTA-Upgrade  
firmware via  
SMS.



Automatic  
APN detection  
on selected  
major  
networks.

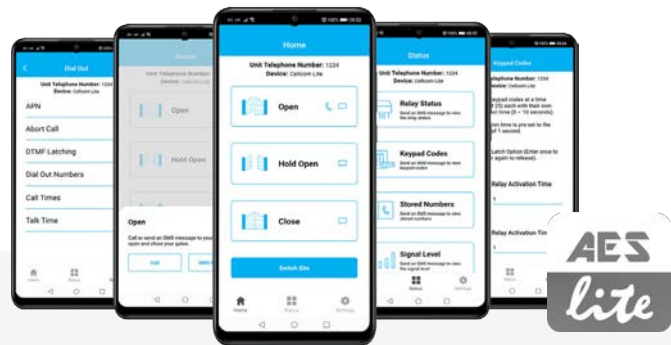

The Lite system works with our user-friendly AES Lite App, designed for both installers and homeowners. Available on Android and iOS, the updated app now features useful additions such as an **Events Log**, **Technical Information**, and more.

### LITE-IBK (Also available in IB)

IMPERIAL MODEL – All black hooded panel with fully customisable blue or white lighting.

Each kit contains, a speech panel, power supply, antenna, and information flyer (including sim card options).

Works with our multi network AESIM.

[aesglobaltelecom.com](http://aesglobaltelecom.com)



GSM

### DETAILS

Dial Out Numbers	3	Relays	1
Permanent Codes	25	Relay Type	N/C and N/O
Permanent Caller ID Numbers	25	Relay Load	2 amps, 24v ac max
Power Consumption	100mA on dial out, 220mA peak demand	Power Supply	24v dc (24v dc 2A adaptor included)
Modem Models	4G Europe, 4G USA, 4G AUS/NZ		

# CELLCOM LINK

## Multi-Call Station System

(Available in Lite and Prime Versions)

The multi-callpoint station is a system that is designed for those entry ways for both large and small vehicle access. Having two call points at separate heights but operating from one GSM module, this allows the two call points to operate from one 4G SIM card. Ideal for commercial entrances that see high traffic of both light and heavy vehicles.

### Multi-call system/2 part high security.

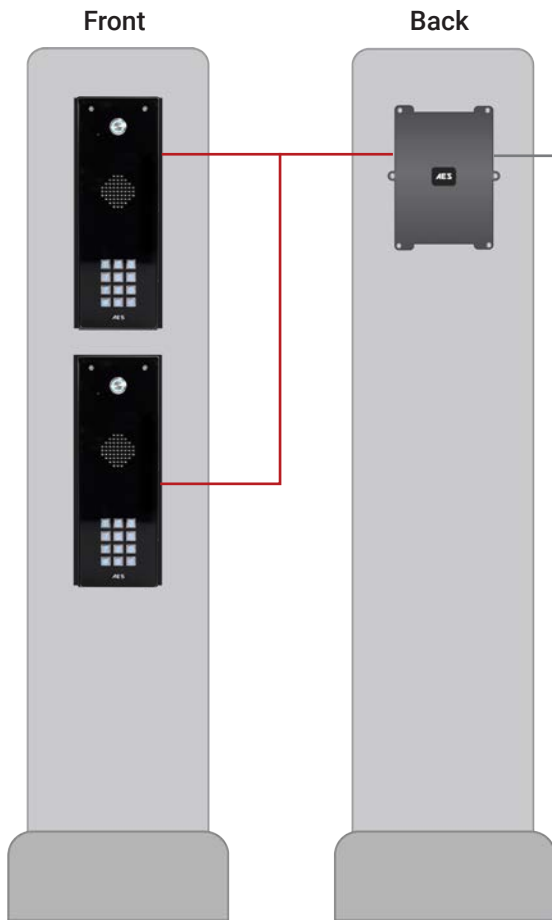

GSM

### LITE-LINK-EU

Includes Cellcom Link-Lite PCB.



Works with our multi network AESIM.



Puck antenna comes as standard.

Comprehensive event log of last 20 events.

10 metres max shielded Cat5 cable between Call Point(s) & Cellcom Link.

Call up to 3 numbers in a sequence.



Fixed land line.



Cell/Mobile phone.

\*Available as a wireless audio handset system.

Cellcom Lite Speech Panel: LITE2-CP-IBK

Features	Lite	Prime
Dial Out Numbers	3	4
Multi Button Connections	NO	YES
Time Sync	SMS only	SMS or NTP server
Relays	1	2
SMS Reboot	NO	YES
Events Log	YES	YES
FOTA & USB-C	YES	YES

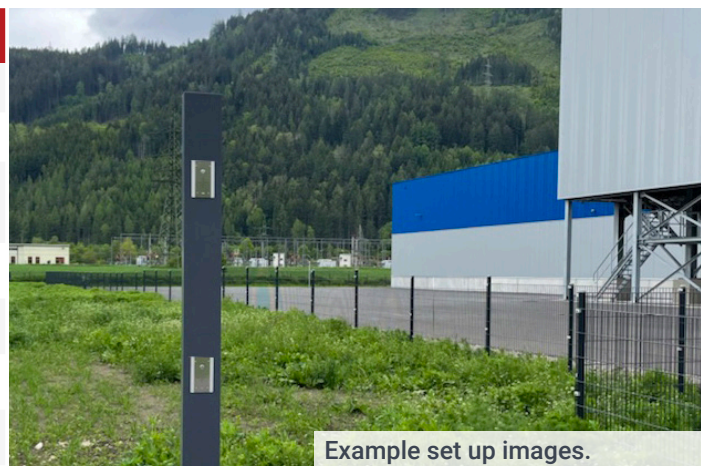

Example set up images.

# MULTICOM CLASSIC

## Multi Family Intercom

Calls up to 500 apartments from a single SIM card.

(3 users per apartment)

Visitors can scroll for residents, or enter apartment number to call.

HD voice with VoLTE\*.

Prox reader comes as standard.

Built in time clock for auto opening and closing of gates, barriers or doors in busy periods or for daytime operation.

Do not disturb feature.

\*Requires correct APN to be set and will only be experienced on a VoLTE enabled device.



GSM

### GSM Cloud Portal

With the **AES Cloud Portal**, building managers and installers can remotely program and manage their **Multicom Classic** units anytime, from any location.

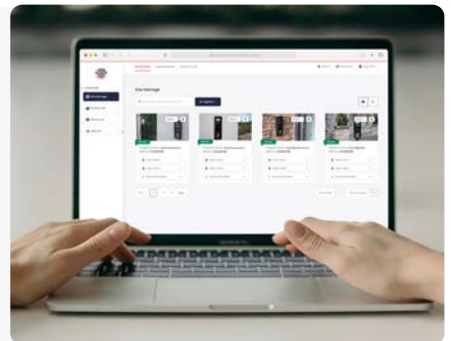

- Remote programming.
- SMS message reduction.
- Simplified management.
- User Friendly.

### DETAILS

Dial Out Numbers per Apartment	3 per apartment (1500 Total)	Relays	2
Keypad Codes per Apartment (6 digit)	1 per apartment (500 Total)	Relay Type	N/C and N/O
Prox Cards/Tags per Apartment	3 per apartment (1500 Total)	Relay Load	2A , 24V AC max
Automatic Trigger Events per Week	10	Power Consumption	310mA on dial out, 2A peak demand
Modem Models	4G EU, 4G USA, 4G AUS/NZ	Power Supply	24V DC (24V DC 2A adaptor included)

### VISITOR CODES/CARDS

	Permanent	Time-restricted	Temporary
Visitor Prox Cards, Keypad Codes (4 digits), Caller ID	250	250	50



Programmable with the  
AES PRO APP.



The Multicom Classic is available in imperial or flush style panels.

Each kit contains, a speech panel, power supply, install manual, SIM card options and a high gain antenna. Plus card/tags for handy prox access.



Antenna.

GSM



Sleek all-black panel  
with blue lighting.

**MULTI-CL-IBK-EU**



**MULTI-CL-FBK-EU**

Modular Flush configuration.

Full steel panel with white  
lighting.

**MULTI-CL-ISK-EU**



Area code:  
EU (Europe)  
US (USA)  
AU (Australia & NZ)

**MULTI-CL-PBK-EU**



Works with our multi  
network AESIM.

[aesglobaltelecom.com](http://aesglobaltelecom.com)





# i-GATE PLUS

ADVANCED GSM GATE OPENER

## i-GATE PLUS

The latest i-Gate Plus is an upgrade to our Advanced GSM Gate Opener, the i-Gate 1200. This unit hosts new features that improve functionality and performance.



GSM



\*e-Loop/e-Trans sold separately.

### E-LOOP INTEGRATION

The i-Gate Plus also integrates connection features with our e-Loop\* range!

### Key Features of i-Gate Plus:

- 1200 - Numbers for caller ID access.
- Store up to four phone numbers to receive SMS alerts each time the unit is used to grant access.
- SMS passcode access for non stored numbers.
- FOTA – Upgrade firmware via SMS.
- Check stored numbers by SMS.
- Activity log feature.
- 1 - Volt free momentary relay outputs.
- Auto call feature to schedule outgoing call (prevents SIM card being deactivated).
- Includes 7 day time clock.
- Program times for the relay(s) to operate automatically.
- Trigger, latch and unlatch gates by SMS or with app.

GSM gate opener with IOS and Android applications. Programmable with the AES LITE APP\*.



DETAILS	
Power	12-24v ac/dc (not supplied)
Current	45mA (standby). 200mA (when called)
Weather Rating	IP67
Relay Load	24v 2A
Relay Type	N/C and N/O. Latching & momentary



# i-GATE DUAL

ADVANCED GSM GATE OPENER

## i-GATE DUAL

Unlock access with a call- relay GSM switch with seamless cloud set up and full wireless e-loop compatibility.



i-GATE-DUAL-EU



Programmable with the AES PRO APP.

Works with our multi network AESIM.

[aesglobaltelecom.com](http://aesglobaltelecom.com)



### Key Features of i-Gate DUAL :

- Cloud compatible.
- E-loop integration plugin PCB.
- RGB status for instant indication of devices network connectivity.
- Push-to-exit select relay 1 or 2 and also set active times of operation.
- Automatic Daylight Savings Time (in NTP sync mode).
- Customisable SMS replies.
- Automatic APN detection on selected major networks.
- Remote sms diagnostics features including modem reboot and dial test.
- Regular status reports-choose between daily and weekly reports to confirm online status.
- Comprehensive events log including automatic openings, push-to-exit events, and SMS and E-loop operations.

## GSM CLOUD PORTAL

With the **AES Cloud Portal**, building managers and installers can remotely program and manage their **i-Gate Dual** units anytime, from any locations.

- Reduce SMS messaging
- User-friendly interface
- Simplified intercom management
- Remote programming

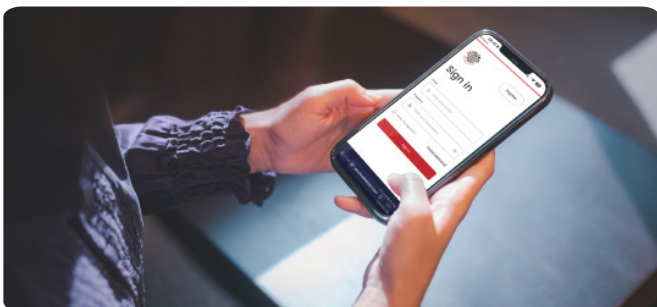

Details	
Weather rating	IP67
Relays	2
Relay Type	N/C and N/O
Relay Load	24V 5A
Power Consumption	30mA (standby). 80mA (when called)
Modem Model	4G
Power	12-24v AC/DC (units applied)
Caller ID number	1280
Time restricted ID Numbers	250
Automatic trigger event per week	50
Push-to-Exit timed event per week	5



# AESIM

## AES Multi-Net SIMs

### What are AES SIMs?

AES has worked very closely with a local network to offer the perfect plan and tariff to accommodate use in our devices, they are UK based by default with the option to rent a local number\* in certain areas.

All our GSM / 4G intercoms now come with a MULTI-NET SIM! If the system loses its current connection it will automatically reroute to the next best connection available.

GSM

***Always stay connected!***

[www.aesglobaltelecom.com](http://www.aesglobaltelecom.com)



GSM Intercom



AESIM

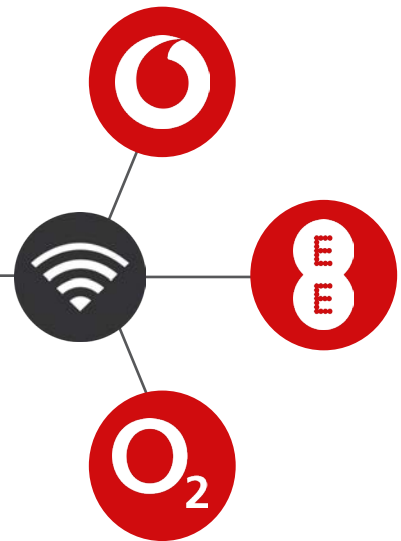

Multi Networks\*

\*UK example - other networks available for different regions.



Please visit [www.aesglobaltelecom.com](http://www.aesglobaltelecom.com) to activate the sim cards, we can provide a mobile number local to your region.

For sim card support:

E. [support@aesglobaltelecom.com](mailto:support@aesglobaltelecom.com)

TEL. +44 (0) 288 639 0 693

# CELLCOM KEYCELL

GSM

**Gate/Entrance 1**  
KEY-MST-PBK-EU



**Gate/Entrance 2**  
KEY-AUX-PBK-EU



**Gate/Entrance 3**  
KEY-AUX-PBP-EU



Standalone GSM/4G keypad system. A great solution for security by covering those extra entrances/gates/doors.

- Up to 6 auxiliary units can be connected to a master unit: Relay 1 and 2 on master unit; relays 3 to 8 on auxiliary units.
- KP and PX as standard.
- DDA LEDs on each auxiliary unit indicates correct or incorrect code/card used.
- Relay on every auxiliary unit that can be set via a dip switch.
- Keypad tones/ confirmation sound can be adjusted on auxiliary units.
- Units are wired via 5 cores of cat 5 cable. (Separate PSU depending on distances).
- 100m total cable length. An extra PSU required every 20m.

## DETAILS

Power	24V D.C
Current	300mA/2A Peak 100mA Per Auxiliary Unit
Weather Rating	IP55
Relay Type	2 x N/C & N/O Contacts
Total Permanent Keypad Codes	250
Total Permanent Prox Cards	250
Time Restricted Codes/Cards	250
Temporary Codes/Cards	50



**Master Unit:** Keypad, Prox readers with built-in transmitter.

**Auxiliary Pedestal:** Keypads & Prox readers.



**KEY-MST-PBK-EU**  
Master unit with keypad & prox reader.



**KEY-AUX-PBK-EU**  
Aux pedestal unit with keypad & prox reader.



**KEY-AUX-PBP-EU**  
Aux pedestal unit with prox reader.



Area code:  
EU (Europe)  
US (USA)  
AU (Australia & NZ)

IP/4G



GSM



WIRELESS

# WIRELESS

Intercom System with a cordless telephone.

\*603 & 703 SYSTEMS ONLY

SPECIAL PRODUCT



# DECT 603

Digital Enhanced Cordless Telecommunications

Simple Wireless Access

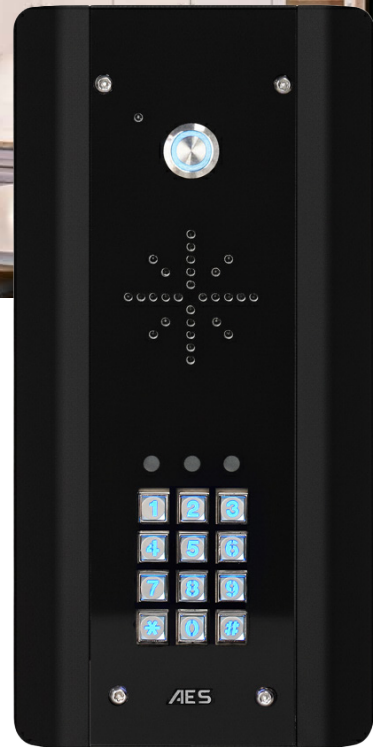

Handsfree wall/desk mount or cordless portable handset options.

- Up to 400 metres open field range!
- Working range of 200 metres through 1 exterior concrete, brick or stone wall.
- Up to 4 handsets/indoor units per system.
- Built in voicemail feature to record missed callers at your door or gate (playback from handset - English & French only).
- Intercall between handsets.

High quality speech panel options.

WIRELESS

## DETAILS

Outdoor Speech Panel		Indoor Handsets	
Relays	2	Power Supply	Charging Base = 5V DC Wall Unit = 12V DC
Keypad Relays	3	Volume Adjust	Yes
Power Supply	24V AC/DC (24V DC 2A adaptor included)	Voicemail Capacity	16
Current Consumption	65mA Standby, 400mA Calling	Calling Between Handsets	Yes
Keypad codes/Prox cards	1200 total across 3 relays.		

The DECT 603 range is available in a variety of intercom panels.

Area code:  
EU (Europe)  
US (USA)  
AU (Australia & NZ)

Each kit contains, a speech panel, power supply, install manual, transmitter, portable handset OR desktop/wall-mounted handset.

## 603-ABK-EU & 603 AB-EU

Architectural Models: Stylish black/steel panels with backlighting and blue buttons & blue back lighting.



603-ABK-EU



603-AB-EU (NON KP)

## 603-IBK-EU & 603 IB-EU

Sleek all-black panels, with modern blue lighting.



603-IBK-EU



603-IB-EU (NON KP)

WIRELESS

For kits with the desk/wall-mounted handsfree handset.

Add HF to product code:

**603-HF-ABK-EU**





# DECT 603 Accessories

## Audio Handsets

Additional handsets (up to total of 4 max per intercom, which can be a mix and match of both styles.)

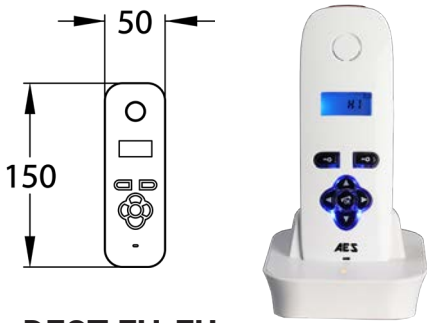

**DECT-EH-EU**

Handsfree Handset comes with charging base & power supply.

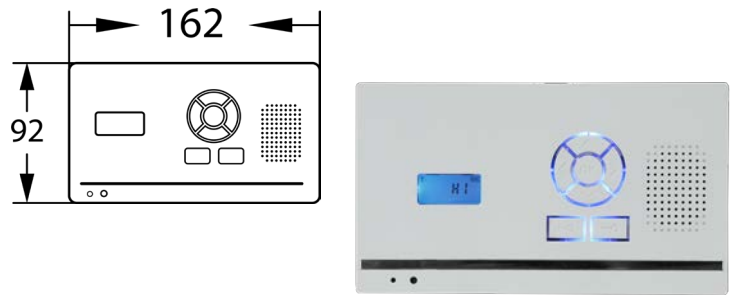

**DECT-HF-EH-EU**

Handsfree Handset comes with wall mount bracket and power supply (desk mount bracket sold separately).

## Boost Antenna

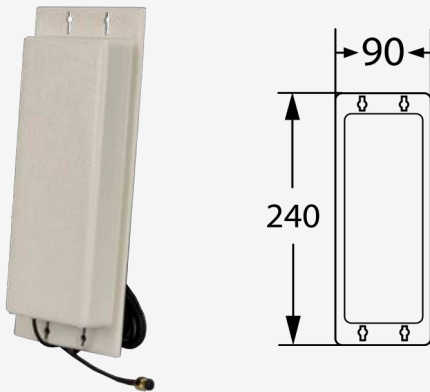

**603-WIFIA-EU**

Range boosting antenna which can be added to transmitter at gate and also optionally to the handsfree monitor type. One antenna can boost range by 30%. Comes with 2 metre antenna cable (RG174 with SMA male connector).

WIRELESS



# DECT 703

## Wireless Multi-Button Intercom

- Digital D.E.C.T wireless intercom system for flats, apartments or shared gate entrances.
- Up to 4 call buttons, each button calling a different handset.
- Working range of 200 metres through concrete (up to 400 metres open field). Simple setup and install.
- 1 handset per property or apartment.
- Keypad for coded access (Panels with built-in prox reader available).
- Built in voicemail feature for missed callers, user can listen to messages on the handset. (playback from handset - English & French only).
- 2 Relays.



WIRELESS

### DETAILS

Power Supply	24V AC/DC (24V DC 2A adaptor included)	Cable Between Speech Unit & Transmitter	4 metre screened CAT5 included.
Current Draw	50mA standby, 1 amp peak	Max Cable Length	8 metres max.
Relay Outputs	2	Cable Cores	2 x SPK, 2 x MIC, 2 x button, 2 x relay, 2 x power.
Relay Time	Adjustable, 1,3,5,9 secs	Calling Between Handsets	Yes
Relay Load	Max 2A, 24V AC	Keypad Programming	On the keypad.
Handsets per System	4 (Depending on speech panel - max 1 per button)	Keypad Codes & Prox cards/tags.	1200. (Across 3 separate relays)
Range	Practical working range of 200 metres. 400 metres open field conditions		



### 703-IBK2-EU

2 button kit with 2 handsets,  
hooded panel with keypad.



### 703-IBK3-EU

3 button kit with 3 handsets,  
hooded panel with keypad.



### 703-IBK4-EU

4 button kit with 4 handsets,  
hooded panel with keypad.

The DECT 703 Modular is available in a sleek imperial style panel with blue lit buttons & keypad.

Each kit contains, a speech panel, power supply, install manual, transmitter, portable handsets OR desktop/wall-mounted handsets.

For kits with the desk/wall-mounted handsfree handset.

Add HF to product code:

**703-*HF*-IBK4-EU**



IP/4G

# OTHER RANGES

MODULAR - E-LOOP - CENTURION LOCK - TOMALOK

GSM

WIRELESS

SPECIAL PRODUCT



# MODULAR RANGE

## MODULAR RANGE ACCESSORIES

### Speaker modules:

MOD-GSM-1B-WIND



GSM MULTI-BUTTON

MOD-PRIME7

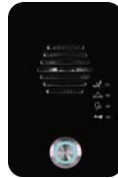

GSM SINGLE BUTTON

MOD-GSM



GSM MUTLI BUTTON MULTICOM CLASSIC

### Call button modules:

MOD-1B



1 Button Module

GSM MUTLI-BUTTON

MOD-2B



2 Button Module

GSM MUTLI-BUTTON DECT 703

MOD-3B



3 Button Module

GSM MUTLI-BUTTON DECT 703

MOD-4B

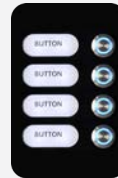

4 Button Module

GSM MUTLI-BUTTON DECT 703

MOD-5B

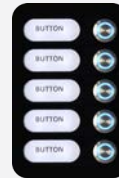

5 Button Module

GSM MUTLI-BUTTON

### Keypad modules:

MOD-PRIME-PX-KP

Combined Prox & keypad



GSM SINGLE BUTTON  
GSM MUTLIBUTTON

MOD-MULTI-PX-KP

Combined prox & keypad



MULTICOM CLASSIC.

### Misc modules:

MOD-BLANK

Blank Module



MOD-CLASSIC

Illuminated info window with scroll buttons.



MULTICOM CLASSIC

All back box panels are available in:



**IMPERIAL**  
**MOD-IB**



**FLUSH**  
**MOD-FB**

Additional styles are available upon a bespoke request. Please note that lead times will apply. For more information about custom units, visit our website, view 38 or contact us directly.



**MOD-IB-1x1**  
1 MODULE UNIT  
162 x 117mm



**MOD-IB-1x2**  
2 MODULE UNIT  
304 x 117mm



**MOD-IB-1x3**  
3 MODULE UNIT  
441 x 117mm

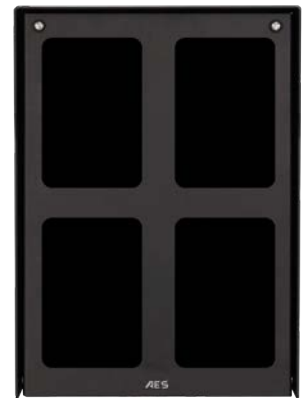

**MOD-IB-2x2**  
4 MODULE UNIT  
304 x 214 mm

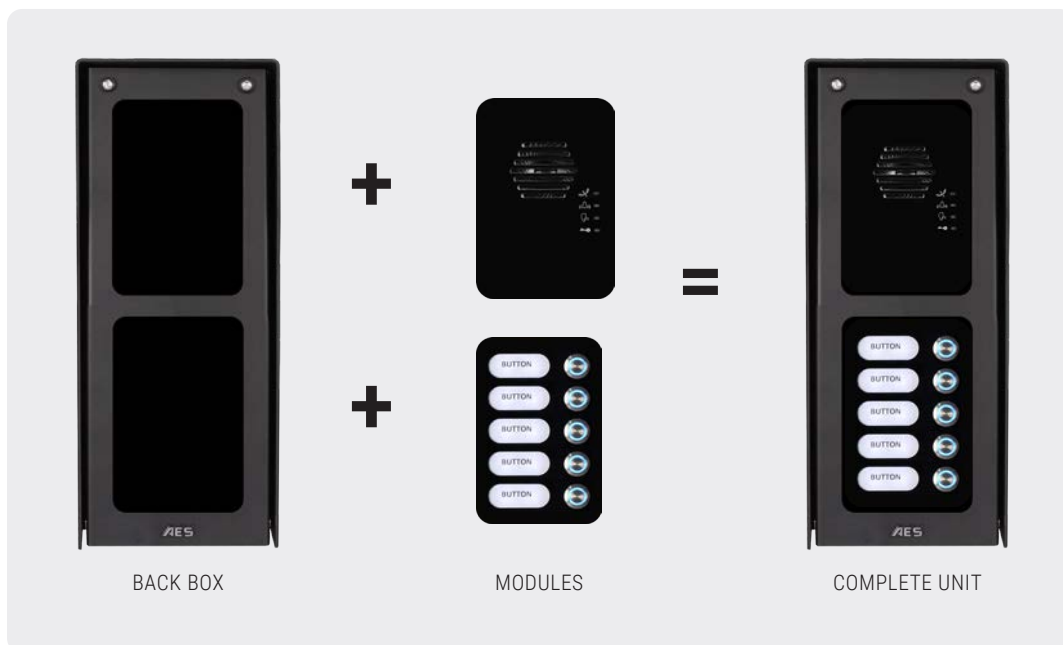

# BESPOKE INTERCOM SOLUTIONS

We can create a bespoke intercom designed to fit your space and requirements. From homes to businesses, our solutions combine advanced technology with design.



Request can be made via the AES Bespoke section on our website. But please keep in mind it may take 6 to 9 weeks to complete the bespoke order at an extra cost!

[aesglobalonline.com/bespoke](https://aesglobalonline.com/bespoke)

## Disclaimer

Please be aware that bespoke orders typically require 6 to 9 weeks to complete and incur additional costs. While we aim to accommodate a wide range of customisation options, certain limitations may apply due to technical or material constraints. Bespoke specifications can also affect production and delivery times, depending on the complexity of the design. A clear timeline will be provided during the consultation process to ensure full transparency.



## RAL Colour Matching

Choose from a range of RAL colour codes to match your property's exterior or corporate branding.

## Unique Shapes & Layouts

Whether you require a vertical design, a horizontal unit, or a completely custom shape, we can accommodate a wide range of design requests.



## Custom Engraving & Finishes

Add a personal touch with engraved names, house numbers, company logos, or symbols.

SPECIAL PRODUCT





Mini



CE

# WIRELESS VEHICLE DETECTION SYSTEM

The e-Loop Mini replaces traditional wired inductive loops, saving you time and money while increasing reliability!

The Mini e-loop is available in two modes: **PRESENCE MODE WITH ADDED RADAR PROTECTION** OR **EXIT MODE**.

Wireless Vehicle Detection System uses magnetometer sensors to detect the presence and movement of vehicles. These detections are transmitted to a nearby transceiver for gate activation. The sensors are installed on the surface of entry or exit passages using concrete fixing bolts, and contain two replaceable AA batteries.

*For low-traffic single residential/domestic settings.*

## FEATURES

- Quick and easy installation.
- Small compact design (120mm x 120mm x 30mm high) (4.7" x 1.1").
- Static load capacity 2.5 Tonnes.
- Uses standard 1.5V AA Lithium batteries (included).
- Providing up to 3-4 years battery life.
- High security 128-bit encryption.
- Range up to 50 meters/yards.



Now available in presence mode. This mode intelligently keeps gates/entrance open for an extended duration when longer vehicles are in motion over the detection area.



SPECIAL PRODUCT



Mini

**EL00M**

**E-loop Mini Domestic loop ONLY EXIT MODE.**

1 x e-Loop Mini domestic Exit mode.



**EL00M-K**

**E-loop Mini Domestic loop kit EXIT MODE.**

1 x e-Loop Mini Exit mode.  
1 x e-Trans 50.  
2 x Concrete fixing bolts.



**EL00M-KT**

**E-loop Mini Domestic loop kit EXIT MODE with 2 channel transceiver.**

1 x e-Loop Mini Exit mode.  
1 x e-Trans 100.  
2 x Concrete fixing bolts.



**EL00M-KLT**

**E-loop Mini Domestic loop kit EXIT MODE with LCD Transceiver.**

1 x e-Loop Mini Exit mode.  
1 x e-Trans 200.  
2 x Concrete fixing bolts.



Micro

**EL00MIC**

**E-loop Micro Domestic loop ONLY PRESENCE MODE.**

1 x e-Loop Micro domestic Presence mode.



**EL00M-K**

**E-loop Mini Domestic loop kit EXIT LOOP.**

1 x e-Loop Micro Presence mode.  
2 x Concrete fixing bolts.  
1x magnet  
1 x e-trans 20

SPECIAL PRODUCT



CE

EL00C-RAD

# Commercial e-Loops

Both e-loop models are available in two modes: **PRESENCE MODE WITH ADDED RADAR PROTECTION** (Holds gate open when a vehicle is over loop). OR **EXIT MODE**.

- Quick and easy installation.
- Not effected by ground movement.
- High security 128 bit encryption.
- Range 50 metres/yards.
- IP68.

## Commercial E-loop Surface Mounted.

- Dual sensing technology. (EL00C-RAD only).
- Compact profile – (220mm x 28mm) (8.6" x 1.1").
- 10600 mA battery (included) giving up to 6-10 years battery life (depending on mode).
- Made of high-impact plastic (10 tonne static load limit).

## Commercial Inground E-loop.

- Dual sensing technology. (EL00IG-RAD only).
- Recesses into the driveway – 55mm in ground height x 89mm diameter (2.1 x 3.5 Inches).
- 14500 mA battery (included) giving up to 6-10 years of battery life (depending on mode).
- Top access for changing the battery.



CE

EL00IG-RAD



SPECIAL PRODUCT

## PRESENCE MODE WITH ADDED RADAR PROTECTION.

Dual sensor technology. Magnetic field and Radar detection.

### Kits with Trans 50:

#### EL00C-RAD-K

##### e-Loop Commercial Radar Loop kit PRESENCE MODE.

- 1 x e-Loop **Presence mode**.
- 1 x e-Trans 50 (transceiver).
- 2 x Concrete fixing bolts.
- 1x Magnet.



#### EL00IG-RAD-KT

##### e-Loop inground commercial Radar loop PRESENCE MODE with a 2-channel transceiver.

- 1 x e-Loop inground **Presence mode**.
- 1 x e-Trans 100.
- 1x Magnet.



#### EL00IG-RAD-K

##### e-Loop inground commercial Radar loop PRESENCE MODE.

- 1 x e-Loop inground **Presence mode**.
- 1 x e-Trans 50.
- 1x Magnet.



### Kits with Trans 200:

##### e-Loop Commercial Radar Loop kit PRESENCE MODE with LCD Transceiver.

- 1 x e-Loop **Presence mode**.
- 1 x e-Trans 200.
- 2 x Concrete fixing bolts.
- 1x Magnet.



### Kits with Trans 100:

#### EL00C-RAD-KT

##### e-Loop Commercial Radar Loop kit PRESENCE MODE with a 2-channel transceiver.

- 1 x e-Loop **Presence mode**.
- 1 x e-Trans 100.
- 2 x Concrete fixing bolts.
- 1x Magnet.



##### e-Loop inground commercial Radar loop PRESENCE MODE with LCD Transceiver.

- 1 x e-Loop inground **Presence mode**.
- 1 x e-Trans 200.
- 1x Magnet.



SPECIAL PRODUCT

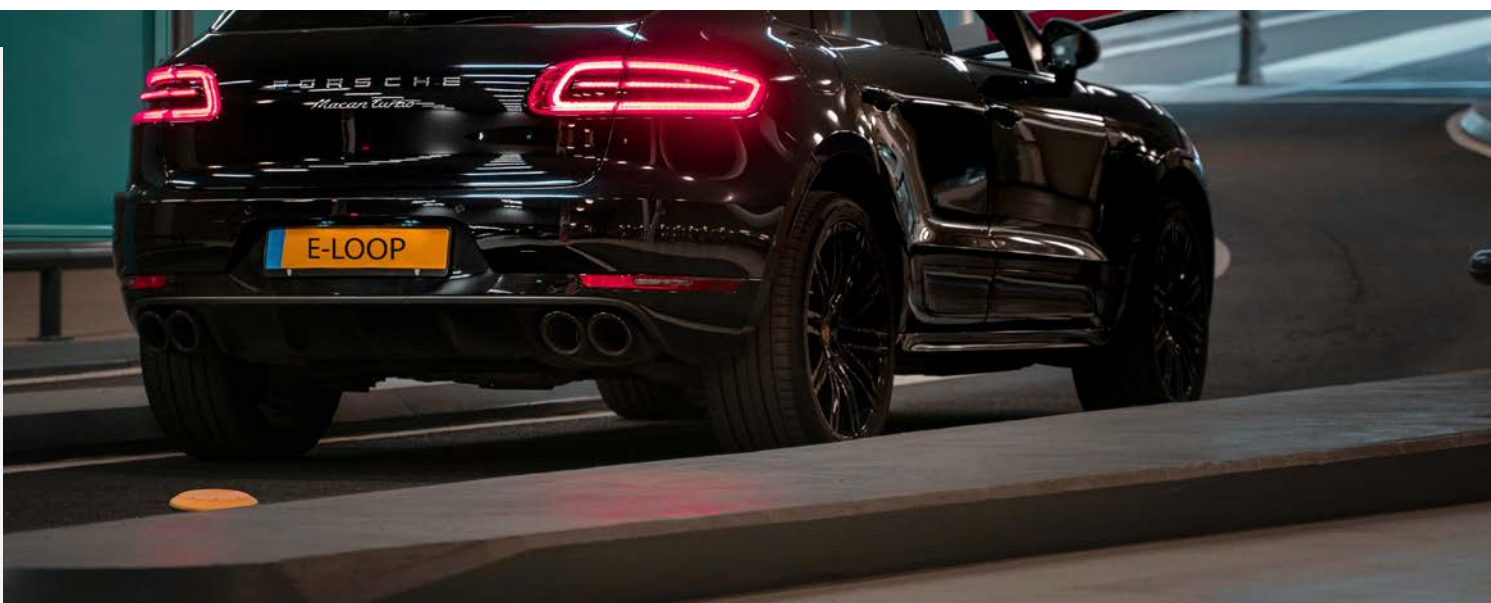



# POST MOUNT VEHICLE DETECTION SYSTEM

The Post Mounted Wireless Vehicle Detection System uses military grade magnetometer sensors. With added radar confirmation, to detect the presence and movement of vehicles. Simply code the Post Mount to the included transceiver, calibrate and you're ready to go. Once the sensor has detected a vehicle, a signal is sent to a nearby transceiver. Capable of operating in all weather conditions.

Note: Gate or door controller must have a dedicated open input and an auto close function enabled.



## FEATURES

- Available in presence mode with magnetic field and radar detection.
- High-security 128-bit encryption.
- Compact profile – 176mm H x 70mm W x 30mm D (6.9”H x 2.7”W x 1.1”D).
- 2 x 1.5 V 3000ma AA Lithium Batteries.
- Up to 3 years of battery life.
- IP68.

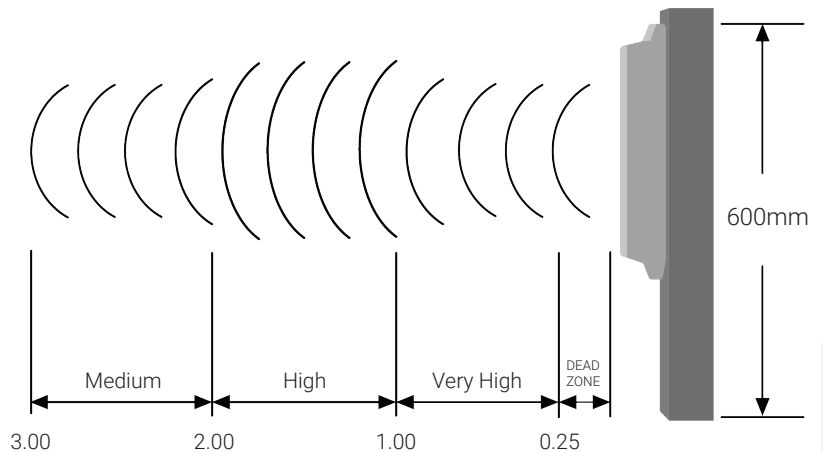

### EL00PM-RAD-K

Post Mount Kit - **PRESENCE MODE.**

- 1 x Post Mount e-Loop Presence mode.
- 1 x e-Trans-50.



### EL00PM-RAD

Post Mount **PRESENCE MODE.**

- 1 x Post Mount e-Loop Presence mode.



SPECIAL PRODUCT



## E-KEYPAD - AES WIRELESS KEYPAD

The e-Keypad offers a sleek access control solution, ideal for systems needing many codes. It features 3 unique channels and advanced settings for installers and supervisors. Integrates seamlessly with the loop range allowing for a secure entrance, and an easy exit.



### FEATURES

- Quick installation with just 2 screws and no wiring
- 433.39 MHz Transceiver.
- Waterproof housing.
- Operates from a single coin cell 2450 lithium battery
- Can be unlocked and used as an entry button.
- Compatible with any Transceiver or gate controller
- Store up to 200 user codes.
- Simple 4 to 8 pin code operation.
- Supervisor Code Storage: 1 Code.
- Establish codes that are valid for a limited number of uses.

### MORE INFO

- Voltage: 3V DC.
- Current draw standby: 200 nA.
- Peak current draw: 10 m/a.
- Battery type: CR2450.
- Battery type: 540 m/a.
- Frequency: 433.39 mHz.
- Channels: 3 Channels.
- Size: 132mm x 90mm x 20mm.
- Encryption: AES 128-Bit.

#### EKPD-K

1 x AES Wireless Keypad.  
1 x e-Trans-50.



#### EKPD

1 x AES Wireless Keypad.





## e-Loop with e-Trans-Plus plug in

Get more out of the e-Loop by connecting the e-Trans-Plus plug-in. This device plugs into our latest I-gate unit the I-Gate-Plus, which gives the user extra features.

- Set auto relay times.
- Set do not disturb times.
- SMS low battery notification.
- Set e-Loop lock out times.
- Program mode.

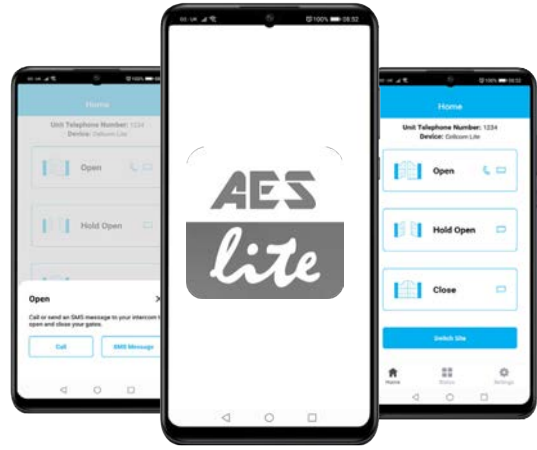

Programmable with the AES LITE APP.

## PRESENCE MODE WITH ADDED RADAR PROTECTION.

Dual sensor technology - Magnetic field and Radar detection.

### EL00IG-RAD-KPT

- 1 x e-Loop inground **Presence mode**.
- 1 x e-Trans-Plus (Plug in).
- 1 x I-Gate-Plus.
- 1x Magnet.



## Commercial Kits:

### EL00C-RAD-KPT

- 1 x e-Loop commercial **Presence mode**.
- 1 x e-Trans-Plus (Plug in).
- 1 x I-Gate-Plus.
- 2 x Concrete fixing bolts.
- 1x Magnet.

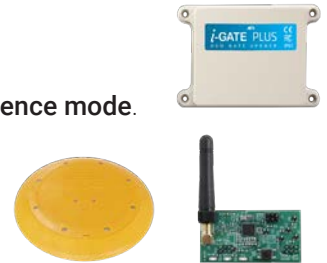



# e-Loop Accessories

## Transceivers / Remotes / Antenna.



### ETRANS50

E-Trans 50 Transceiver.



### ETRANS100

E-Trans 100 - 2 channel transceiver.



### ETRANS200

E-Trans LCD 200 Transceiver.



### EDR00

Diagnostic remote. Bidirectional remote – the ideal tool for the e-Loop range.



### E-TX

4 Key Fob Remote Control. Compatible with all (e-Loop) transceiver products.



### ANT-30

30 dBI antenna for the e-Loop range.



### ANT-4

4 dBI antenna for the e-Loop range.



### E-TRIGGER

#### Wireless relay bridge

With the e-Trigger device you no longer need to wire an intercom (or another 3rd party device) directly into a gate motor. This unit connects to a wireless transceiver housed & connected to the gate motor.

When the gates have been triggered, the e-Trigger device creates a wireless bridge to the transceiver on the gate motor, activating the relay and opening the gates.



SPECIAL PRODUCT

# Tomalok

## The Electric Gate Lock

The Tomalok combines robust engineering and state of the art innovation. With a sleek design, the electric drop bolt seamlessly integrates into your gate system, offering a discreet yet powerful safeguard.

**Lifting force 30N.**

**Overcurrent trip:** yes.

**Current:**

Standby 140mA.  
Peak Draw 280mA.  
Operation 210mA.

**Battery backup time:** over 24hrs + 20 operations.

**Trigger method:** volt free and 24v dc compatible, constant and pulsing compatible.

**Manual override:** Yes.

**Pin:** 150mm Stroke - 20mm diameter stainless steel pin.

**Stainless steel:** Marine grade Stainless steel BS316. (Black unit is powder coated)



**Power:** 24v dc.

**Power cable:** 4 core 5 metres included.

**Power supply type:** Din rail 24v dc included.

**Ground keeper:** optional 2 types (with / without gate stop).

**Mounting method:** M4 jack nuts (included).

**Min recommended gate profile:** 50mm box.

**Unit weight:** 4.5kg.

**Bespoke Colour Only**

**Accessories included:**  
Power supply, protective flexi cable, jack nut fixing tool, keys.

## Gate bolt & power supply kits.



### TL-S-150-KIT

Tomalok Electric Drop Bolt in Stainless - 150mm with 24v Din Rail Power Supply and Ground Plate.



### TL-B-150-KIT

Tomalok Electric Drop Bolt in Black - 150mm with 24v Din Rail Power Supply and Ground Plate.

## Accessories



### TL-GP

Tomalok Ground Plate.



### TL-GS

Tomalok Ground Stop.



### TL-24V

Tomalok 24v Din Rail Power Supply.



### TL-KEY

Tomalok Set of Keys (2).

## Gate bolt, ground stop & power supply kits.



### TL-S-150-KIT

Tomalok Electric Drop Bolt in Stainless - 150mm with 24v Din Rail Power Supply and Ground Stop.



### TL-B-150-KIT

Tomalok Electric Drop Bolt in Black - 150mm with 24v Din Rail Power Supply and Ground Stop.



### TL-BAT

Tomalok Battery (1).



### TL-BAT-SET

Tomalok Set of Batteries (3).



### TL-PCB

Tomalok Main Control PCB.



# RESOURCES



## Product Resources

Manuals - Quick Start Guides -  
Firmware - Videos - Datasheets.

[aesdownloads.bitrix24.site](http://aesdownloads.bitrix24.site)



## Visit our AES Parts website for any spare parts.

[aesglobalparts.store.unleashedsoftware.com/home](http://aesglobalparts.store.unleashedsoftware.com/home) (UK-  
EU)

[aesglobalparts.us](http://aesglobalparts.us) (US-CA)

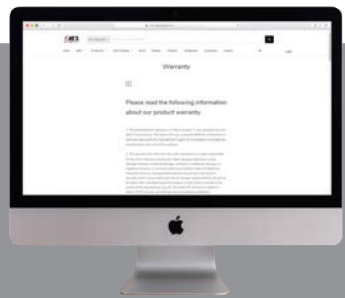

All our products already come with a 2 year warranty,  
if you register with us today we will give you an  
extra 1 year. Offer available in selected countries  
only. Warranty must be registered within 90 days of  
purchase. Proof of purchase required.

[aesglobalparts.com/pages/warranty](http://aesglobalparts.com/pages/warranty)

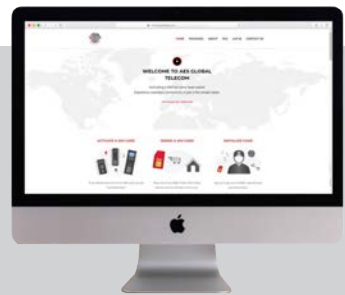

AES Global Telecoms Ltd - With our sim card  
packages you can get connected to your intercom.  
We have packages available in multiple networks  
covering UK, Ireland, USA, & Europe.

[aesglobaltelecom.com](http://aesglobaltelecom.com)



## Contacts:

**Main website: [aesglobalonline.com](http://aesglobalonline.com)**



**For tech support:**

E. [technical@aesglobalonline.com](mailto:technical@aesglobalonline.com)

T. +44 (0) 288 639 0 693

Live chat on website.



**For sales support:**

E. [sales@aesglobalonline.com](mailto:sales@aesglobalonline.com)

E. [orders@aesglobalonline.com](mailto:orders@aesglobalonline.com)

T. +44 (0) 288 639 0 693

Live chat on website.



**For sim card support:**

E. [support@aesglobaltelecom.com](mailto:support@aesglobaltelecom.com)

T. +44 (0) 288 639 0 693

Live chat on website.

The AES logo is rendered in a bold, white, sans-serif font. The letters are thick and blocky, with a slight shadow effect that makes them stand out against the dark background of the rock formations.

**CONTACT US TODAY**

☎ +44 (0) 288 6390 693  
✉ sales@aesglobalonline.com

📍 4C Kilcronagh Business Park,  
Cookstown, BT80 9HJ, UK

**TECH SUPPORT**

☎ T+44 (0) 288 6390 693  
✉ technical@aesglobalonline.com